

A

B

C

D

A

B

C

D

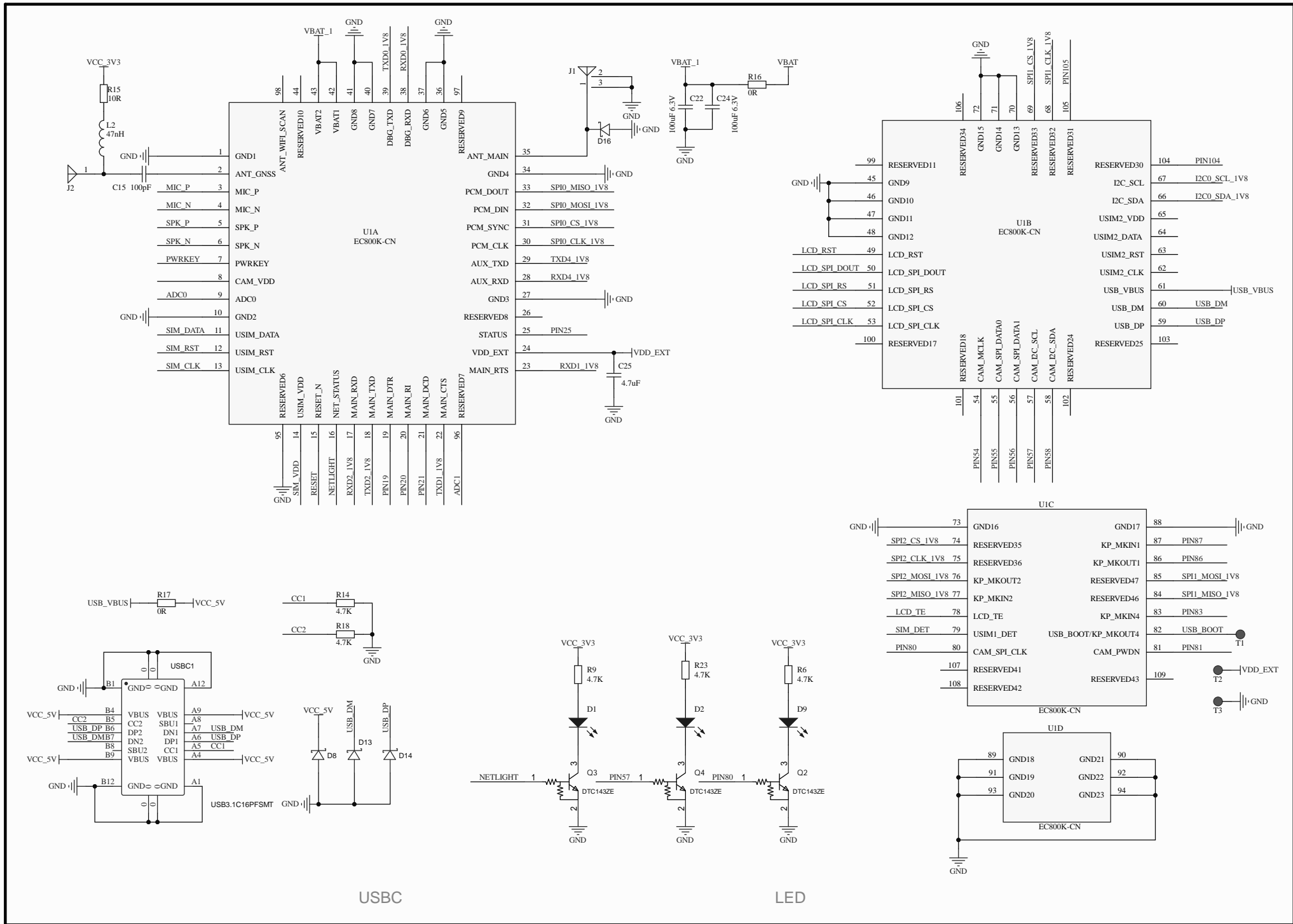

USBC

LED

A2 Tj1 1 1 rg0.1608 0.1608 0.1608 RGET1 JO.7615 wn67541 1593

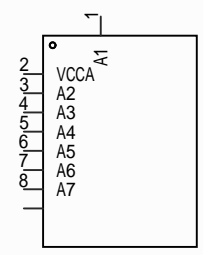
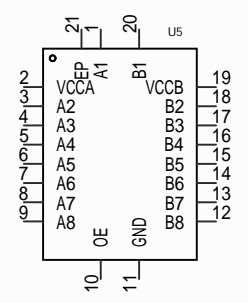
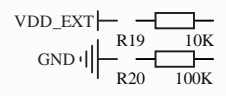
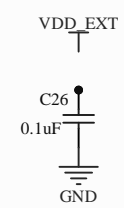
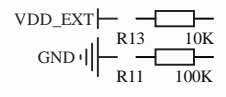
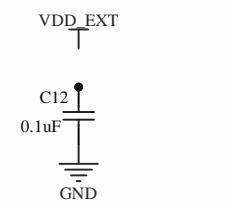
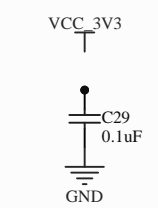
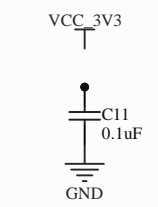
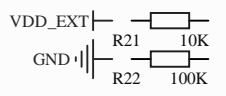
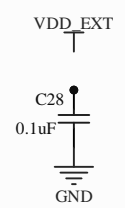
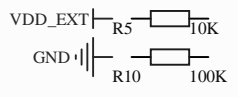
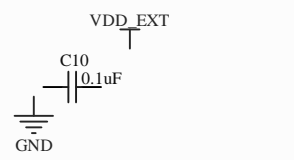

I2C0_SCL_3V3
I2C0_SDA_3V3

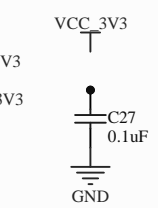
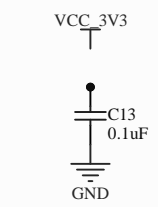

Level Translator

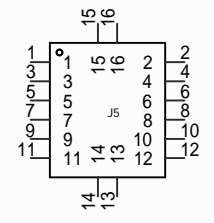
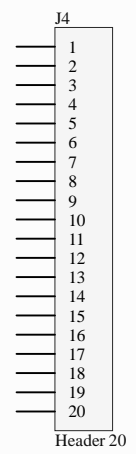
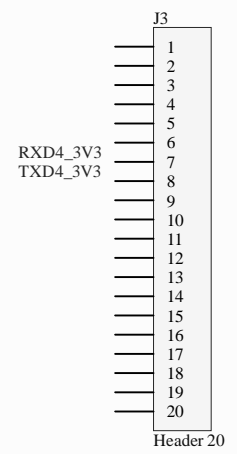

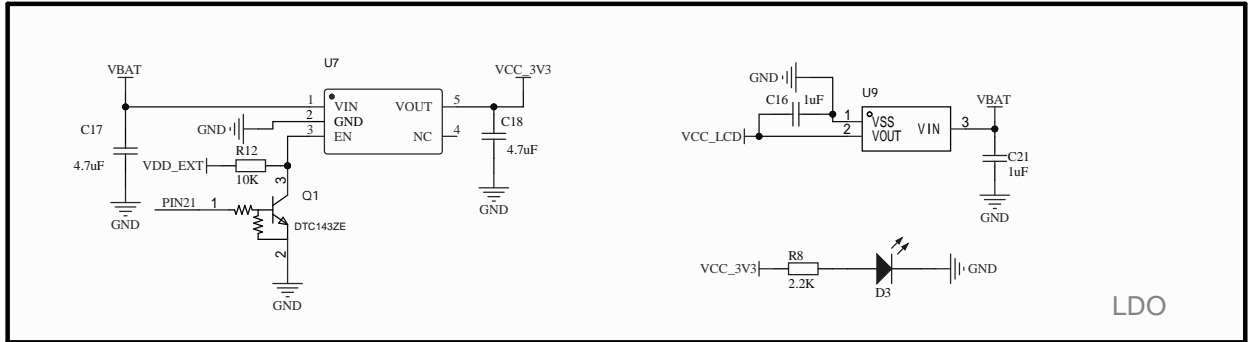

LDO

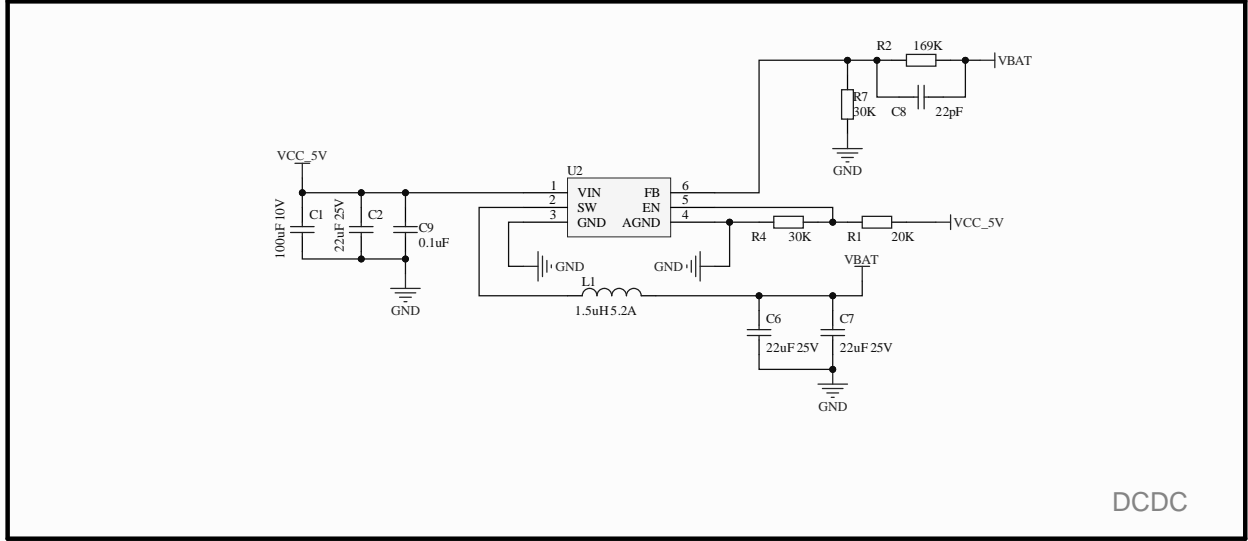

DCDC

1

2

3

4

5

6

A

A

B

B

C

C

D

D

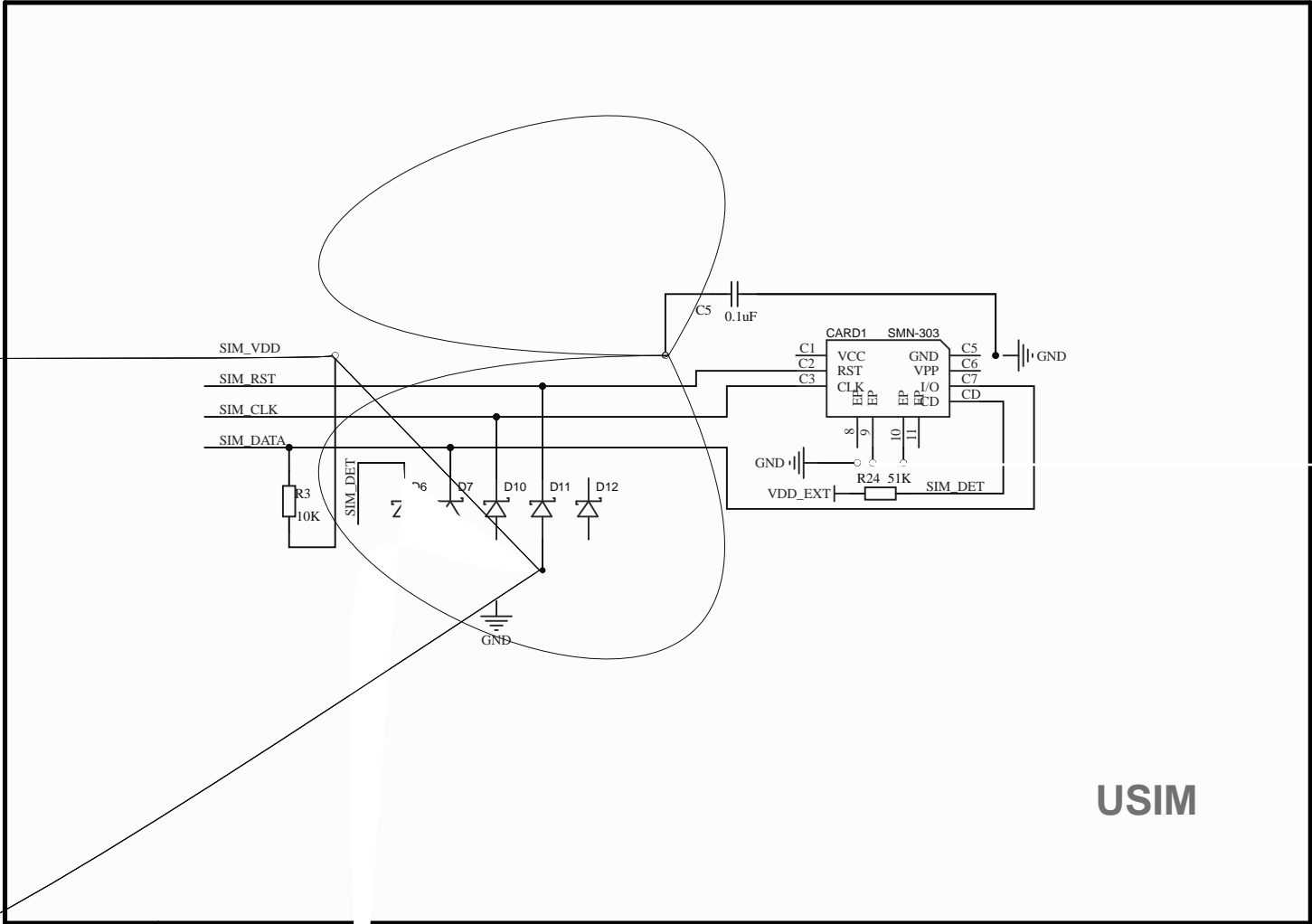

USIM

1

2

3

4

5

6